

Integrated Current Sensor HMSR-DA series

Definition

HMSR DA is a new integrated current sensor with a 1-bit digital bitstream as an output. The innate insulation and Delta Sigma modulator makes it the perfect product to simplify the BOM of your systems. HMSR DA has an integrated micromagnetic core which significantly improves the immunity to external fields. The new Hall cells design together with the internal compensation circuit allows for great effective resolution and accuracy for best-in-class performance. 1-bit bitstream output mode is available on different protocols which include both single ended or differential modes (RS422 and LVDS). This product family provides a robust, compact, and very accurate solution for measuring DC and AC currents in applications like servo drives and robotics. Internal overcurrent detection circuit is implemented in order to provide fast, reliable and flexible protection solutions. This overcurrent detection circuit is located before the Delta Sigma modulator, thus not suffering from its delays. The primary conductor has very low electrical resistance and dedicated pads designed to withstand high surge currents such as lightning strikes. That enables excellent performance at low power losses. The reinforced galvanic insulation between the primary and the secondary eliminates the need for any additional insulation, reducing the total footprint and cost of the system.

Main features & advantages

- Industrial qualification
- Multi-range current transducer up to 75 A
- Low electrical resistance 0.76 mΩ
- 5 V supply voltage
- 1-bit bitstream output from integrated 2nd order sigma-delta modulator Pulse Density Modulation (PDM)
- Different output modes including RS422 and LVDS
- Sensitivity error < 1 % at 35 °C
- Fast internal overcurrent detection < 1.5 μs
- Low power consumption
- Integrated micro core for high robustness against external interference
- Galvanic separation between primary and secondary with 8 mm of d_{cp}/d_{ci}
- Reinforced insulation capability
- Lightning impulse current ≤ 20 kA internal reference voltage
- Small footprint with surface mount PCB mounting
- Temperature range: -40 °C ... 125 °C.

Typical applications

- Servo drives
- Robotics
- Digital drives.

Standards

- IEC 61800-5-1: 2007
- IEC 62109-1: 2010
- IEC 62368-1: 2018 (replacing IEC 60950-1)
- UL 1577: 2014.



Figure 1: HMSR-DA custom package - SOIC-16 compatible

Application circuit and pinout

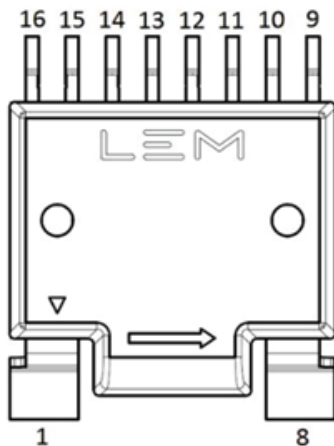

Figure 2: HMSR DA package

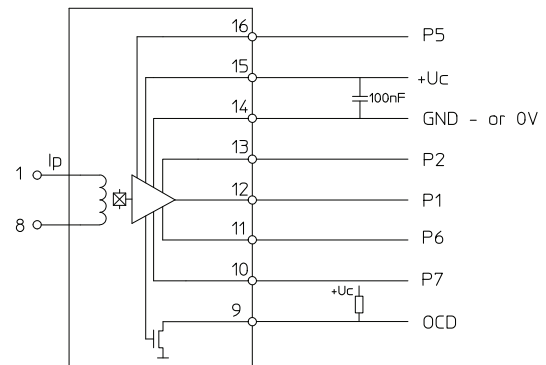

Figure 3: Application circuit

Pin definition

Pin number#	Name	Description
1	I_{p+}	Input of the primary current
8	I_{p-}	Output of the primary current
9	OCD_1	Internal OCD
10	P7	P7
11	P6	P6
12	P1	P1
13	P2	P2
14	GND	Ground terminal
15	U_c	Supply voltage
16	P5	P5

Output mode

Output mode#	P6	P7	P1	P2
0 2W CMOS CLK OUT	NC	NC	CLK	D_{out}
1 2W RS422 MANCHESTER	NC	NC	$\overline{D_{out}}$	D_{out}
2 4W LVDS CLK OUT	CLK	\overline{CLK}	$\overline{D_{out}}$	D_{out}
3 2W LVDS MANCHESTER	NC	NC	$\overline{D_{out}}$	D_{out}
4 4W RS422 CLK OUT	CLK	\overline{CLK}	$\overline{D_{out}}$	D_{out}
8 2W CMOS CLK IN	NC	NC	CLK	D_{out}
A 4W LVDS CLK IN	CLK	\overline{CLK}	$\overline{D_{out}}$	D_{out}
C 4W RS422 CLK IN (Mode C)	CLK	\overline{CLK}	$\overline{D_{out}}$	D_{out}
D 4W RS422 IN (Mode D)	CLK	\overline{CLK}	$\overline{D_{out}}$	D_{out}

HMSR-DA series: name and codification

HMSR-DA family products may be ordered **on request** ¹⁾ with a dedicated setting of the parameters as described below (standards products are delivered with the setting 00000 according to the table).

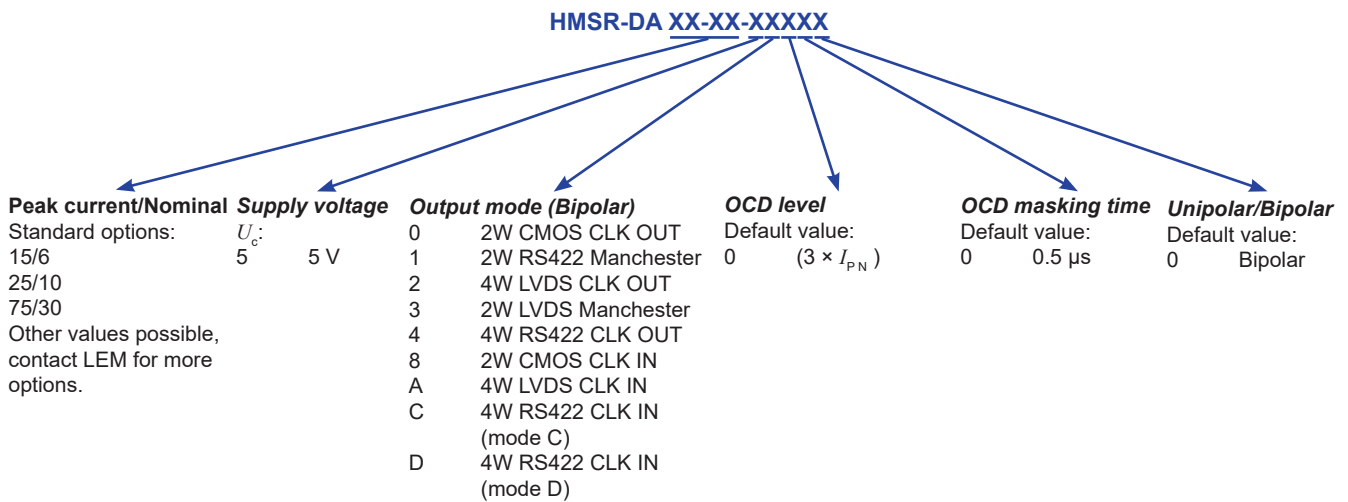

Standard products:

Product name#	Current measurement range	Nominal current (A RMS) ²⁾	Supply voltage U_c	Output mode
HMSR DA 15/6-50000	±15	±6	5 V	2W CMOS CLK OUT
HMSR DA 15/6-54000	±15	±6	5 V	4W RS422 CLK OUT
HMSR DA 25/10-50000	±25	±10	5 V	2W CMOS CLK OUT
HMSR DA 25/10-54000	±25	±10	5 V	4W RS422 CLK OUT
HMSR DA 75/30-50000	±75	±30	5 V	2W CMOS CLK OUT
HMSR DA 75/30-54000	±75	±30	5 V	4W RS422 CLK OUT

Notes: ¹⁾For dedicated settings, minimum quantities apply, please contact your local LEM support.

²⁾Trimming at LEM are done at this nominal current.

Block diagram

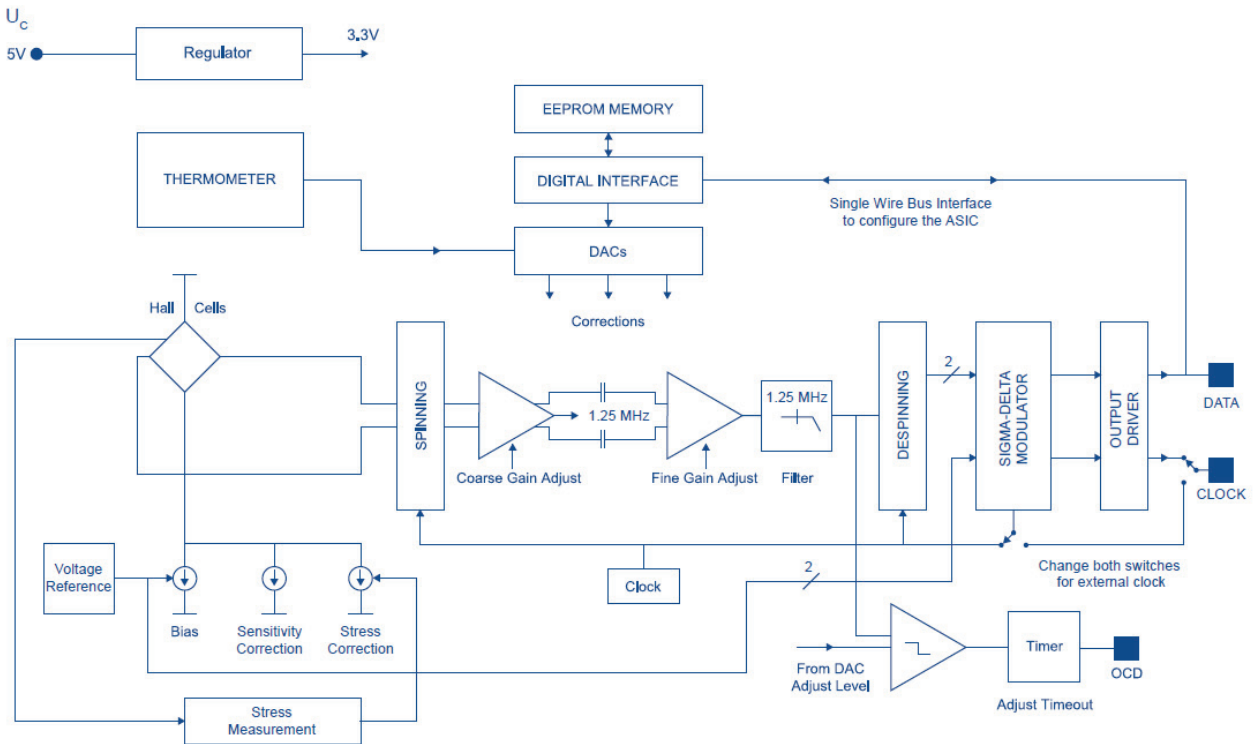

Figure 4: Block diagram

External circuit example

Symbol	Unit	Value	Comment
$R_{1\text{OCD}}$	K Ω	4.7	< 50
C_{supply}	nF	47	< 100

Absolute maximum ratings

Parameter	Symbol	Unit	Value
Maximum supply voltage	$U_{C\ max}$	V	7.5
Maximum supply voltage on other pins	$U_{\ max}$	V	7.5
Electrostatic discharge voltage (HBM - Human Body Model)	$U_{\ ESD\ HBM}$	kV	2
Electrostatic discharge voltage (CDM - Charged Device Model)	$U_{\ ESD\ CDM}$	V	500
Maximum junction temperature	$T_{\ J\ max}$	°C	150

Absolute maximum ratings apply at 25 °C unless otherwise noted.
 Stresses above these ratings may cause permanent damage.
 Exposure to absolute maximum ratings for extended periods may degrade reliability.

Environmental and mechanical characteristics

Parameter	Symbol	Unit	Min	Typ	Max
Ambient operating temperature	T_A	°C	-40		125
Ambient storage temperature	$T_{A\ st}$	°C	-55		165
Resistance of the primary @ $T_A = 25\ ^\circ\text{C}$	R_P	mΩ		0.76	
Thermal resistance junction to board (case) ¹⁾	$R_{th\ JB}$	K/W		18	
Thermal resistance junction to ambient ¹⁾	$R_{th\ JA}$	K/W		19	
Mass	m	g		1.4	

Note: ¹⁾ Done with LEM evaluation board PCB 2702 (0325) described on [page 18](#).

Insulation coordination

Parameter	Symbol	Unit	≤ Value	Comment
RMS voltage for AC insulation test, 50 Hz, 1 min	U_d	kV	4.95 ¹⁾	According to IEC 62368-1
Impulse withstand voltage 1.2/50 μ s	U_{Ni}	kV	8	According to IEC 62109-1, IEC 61800-5-1
Partial discharge RMS test voltage ($q_m < 5$ pC) recurring peak voltage	U_{PDt}	V	1556	According to IEC 62109-1, IEC 61800-5-1
Partial discharge RMS inception voltage	U_{PDi}	V	2063	According to IEC 62109-1, IEC 61800-5-1
Partial discharge RMS extinction voltage	U_{PDe}	V	1650	According to IEC 62109-1, IEC 61800-5-1
Clearance (pri. - sec.)	d_{Cl}	mm	8	Shortest distance through air
Creepage distance (pri. - sec.)	d_{Cp}	mm	8	Shortest path along device body
Case material	-	-	V0	According to UL 94, flammability
Comparative tracking index	CTI		600	Grade requirements mass compound

Note: ¹⁾Tested at 4.45 kV in production.

Working voltage according to IEC 62368-1

Working voltages		PD2	Unit	Standards
Basic insulation	RMS voltage	1600	V	IEC 62368-1 (replacing IEC 60950-1)
	Peak or DC voltage	2262	V	
Reinforced insulation	RMS voltage	800	V	
	Peak or DC voltage	1131	V	

Rated insulation voltage according to IEC 61800-5-1 / IEC 62109-1

Working voltages		OV II/PD2	OV III/PD2	Unit	Standards
Basic insulation	RMS voltage	1520 / > 1000	1000 / 1000	V	IEC 61800-5-1 / IEC 62109-1
	Peak or DC voltage	NA / 1500	NA / 1500	V	
Reinforced insulation	RMS voltage	800 / 800	600 / 600	V	
	Peak or DC voltage	NA / 1131	NA / 848	V	

Common electrical data (independent of sensitivity)

At $T_A = 35\text{ °C}$, $U_C = +5\text{ V}$, unloaded, unless otherwise noted (see Min, Max, typ. definition paragraph in [page 9](#)).

Parameter	Symbol	Unit	Min	Typ	Max	Comment
DC supply voltage	U_C	A	4.5	5	5.5	
Density of ones @ $I_p = 0\text{ A}$	D_{out}	%		50		Over operating temperature range
Density of ones @ $I_p = \pm I_{pN}$				50 ± 16		
Density of ones @ $I_p = \pm I_{pM}$				50 ± 40		
Maximum output current source		mA			25	
Maximum input current sink		mA			50	
Electrical offset for PDM output (@ $I_p = 0$)	D_{OE}	%	-0.1		0.1	Relative to $D_{out} = 50\%$
			-0.15		0.15	-40 °C ... 125 °C
Linearity error 0 ... I_{pN}	ϵ_L	% of I_{pN}	-0.5		0.5	
Linearity error 0 ... I_{pM}		% of I_{pM}	-0.5		0.5	
Magnetic offset current (@ $10 \times I_{pN}$) referred to primary	I_{OM}	A		0.18		
Delay time to 10 % of the final output value for I_{pN} step	t_{D10}	μs			1.5	product only (without filter)
Delay time to 90 % of the final output value for I_{pN} step	t_{D90}	μs			2	product only (without filter)
Internal bandwidth (-3 dB)	BW	kHz		300		product only (without filter)

Remark:

D_{out} is greater than 50 % when I_p flows in the direction of arrow (pin 1 to pin 8).
 D_{out} is lower than 50 % when I_p flows in the opposite direction of arrow.

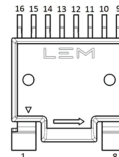

DC current consumption VS output mode

Typical values with $C_L = 5\text{ pF}$.

Output mode	Symbol	Unit	Unloaded	With $R_L = 100\ \Omega$	Comment
0	I_C	mA	24	-	2W CMOS CLK OUT
1	I_C	mA	24	53	2W RS422 MANCHESTER
2	I_C	mA	-	37	4W LVDS CLK OUT
3	I_C	mA	-	30	2W LVDS MANCHESTER
4	I_C	mA	25	82	4W RS422 CLK OUT
8	I_C	mA	24	-	2W CMOS CLK IN
A	I_C	mA	-	30	4W LVDS CLK IN
C	I_C	mA	24	53	4W RS422 CLK IN (Mode c)
D	I_C	mA	24	53	4W RS422 IN (Mode D)

Electrical data HMSR DA 15/6-5X000
 $T_A = 35\text{ °C}$, $U_C = +5\text{ V}$, Mode 4, unless otherwise noted (see Min, Max, typ. definition paragraph in [page 9](#)).

Parameter	Symbol	Unit	Min	Typ	Max	Comment
Primary nominal current	I_{PN}	A		6		
Primary current, measuring range	I_{PM}	A	-15		15	
Nominal sensitivity	S_N	%/A		2.666		16 % @ I_{PN}
Sensitivity error	ϵ_S	%	-0.75		0.75	at 35 °C
			-1.75		1.75	-40 °C ... 125 °C
Sum of sensitivity and linearity error @ $T_A = 35\text{ °C}$	ϵ_{SL25}	% of I_{PM}	-0.8		0.8	
Effective number of Bits	$ENOB$	Bit		12		$I = 0\text{ A}$ Filter SINC 3 OSR 256
Electrical offset current, referred to primary	I_{OE}	mA	-37.5		37.5	
Total error over temperature	ϵ_{tot}	% of I_{PM}		0.8		-40 °C ... 125 °C
Total error over temperature	ϵ_{tot}	% of I_{PM}		0.8		Mode 0: 35 °C ... 125 °C
				1.2		Mode 0: -40 °C ... 35 °C

Electrical data HMSR DA 25/10-5X000
 $T_A = 35\text{ °C}$, $U_C = +5\text{ V}$, Mode 4, unless otherwise noted (see Min, Max, typ. definition paragraph in [page 9](#)).

Parameter	Symbol	Unit	Min	Typ	Max	Comment
Primary nominal current	I_{PN}	A		10		
Primary current, measuring range	I_{PM}	A	-25		25	
Nominal sensitivity	S_N	%/A		1.6		16 % @ I_{PN}
Sensitivity error	ϵ_S	%	-0.75		0.75	at 35 °C
			-1.75		1.75	-40 °C ... 125 °C
Sum of sensitivity and linearity error @ $T_A = 35\text{ °C}$	ϵ_{SL25}	% of I_{PM}	-0.8		0.8	
Effective number of Bits	$ENOB$	Bit		12.5		$I = 0\text{ A}$ Filter SINC 3 OSR 256
Electrical offset current, referred to primary	I_{OE}	mA	-62.5		62.5	
Total error over temperature	ϵ_{tot}	% of I_{PM}		0.8		-40 °C ... 125 °C
Total error over temperature	ϵ_{tot}	% of I_{PM}		0.8		Mode 0: 35 °C ... 125 °C
				1.2		Mode 0: -40 °C ... 35 °C

Electrical data HMSR DA 75/30-5X000
 $T_A = 35\text{ °C}$, $U_C = +5\text{ V}$, Mode 4, unless otherwise noted (see Min, Max, typ. definition paragraph in [page 9](#)).

Parameter	Symbol	Unit	Min	Typ	Max	Comment
Primary nominal current	I_{PN}	A		30		
Primary current, measuring range	I_{PM}	A	-75		75	
Nominal sensitivity	S_N	%/A		0.533		16 % @ I_{PN}
Sensitivity error	ϵ_s	%	-0.75		0.75	at 35 °C
			-1.75		1.75	-40 °C ... 125 °C
Sum of sensitivity and linearity error @ $T_A = 35\text{ °C}$	ϵ_{SL25}	% of I_{PM}	-0.8		0.8	
Effective number of Bits	$ENOB$	Bit		13		$I = 0\text{ A}$ Filter SINC 3 OSR 256
Electrical offset current, referred to primary	I_{OE}	mA	-187.5		187.5	
Total error over temperature	ϵ_{tot}	% of I_{PM}		0.8		-40 °C ... 125 °C
Total error over temperature	ϵ_{tot}	% of I_{PM}		0.8		Mode 0: 35 °C ... 125 °C
				1.2		Mode 0: -40 °C ... 35 °C

Definition of typical, minimum and maximum values

Unless otherwise stated (e.g. "100 % tested"), the LEM definition "min" and "max" is that the probability for values of samples to lie in this interval is 99.73 %. For a normal (Gaussian) distribution, this corresponds to an interval between -3 sigma and +3 sigma. The definition of "typical" is that the probability for values of samples to lie in this interval is 68.27 %, corresponding to an interval between -sigma and +sigma for a normal distribution.

Typical, maximal and minimal values are determined during the initial characterization of the product.

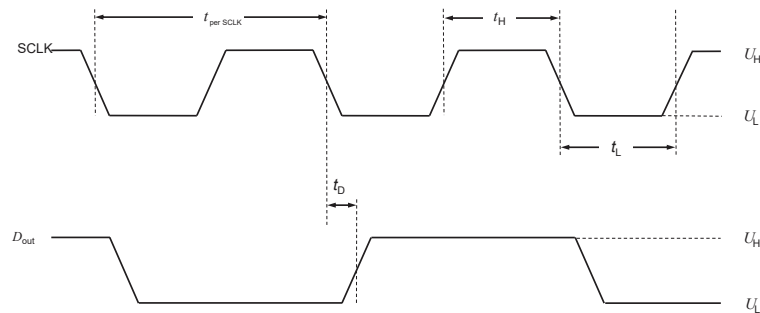
Output mode characteristics
Mode 0 and 8: 2 Wires CMOS

For all allowed capacitive range

- Timing for Mode 0

Parameter	Symbol	Unit	Min	Typ	Max	Comment
SCLK period	t_{SCLK}	ns	89	93.5	98	For internal clock
Temperature coefficient of clock period	$TCt_{\text{per CLK}}$	ppm/K	-400	0	400	-40 °C ... 105 °C
Clock high time	t_{H}	ns	$0.45 \times t_{\text{SCLK}}$	46.75	$0.55 \times t_{\text{SCLK}}$	
Clock falling edge to data delay	t_{D}	ns	-25	0	25	

- Timing for Mode 8

Parameter	Symbol	Unit	Min	Typ	Max	Comment
Clock high time	t_{H}	ns	$0.45 \times T_{\text{CLK}}$	$0.5 \times T_{\text{CLK}}$	$0.55 \times T_{\text{CLK}}$	
Clock falling edge to data delay	t_{D}	ns	13	0	49	

In Mode 8, you can use external clock from 5 to 10.1 MHz or from 11.4 to 12.5 MHz.

- Levels

Parameter	Symbol	Unit	Min	Typ	Max	Comment
Low voltage	U_{L}	V			0.4	with $I_{\text{out L}} = 4 \text{ mA}$, unloaded
High voltage	U_{H}	V	$U_{\text{C}} - 0.4$			with $I_{\text{out H}} = -4 \text{ mA}$, unloaded

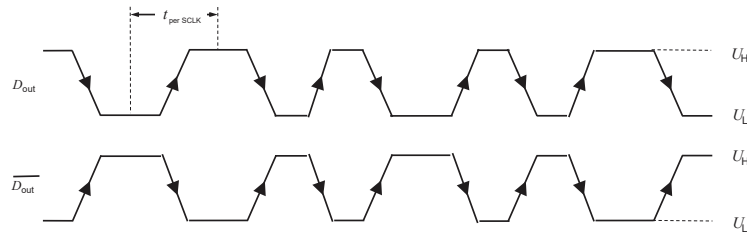
Mode 1: 2 Wires RS422 Manchester (ANSI/TIA/EIA-422-B and IEEE 802.3)

For all allowed capacitive range, R_L can be 100 Ohm.

Logical 1 is coding on a rising edge on D_{out} .

- Timing for mode 1

Parameter	Symbol	Unit	Min	Typ	Max	Comment
SCLK period	t_{SCLK}	ns	89	93.5	98	$f_{CLK} = 10.7 \text{ MHz} \pm 5 \%$
Temperature coefficient of clock period	TCT_{CLK}	ppm/K	-400	0	400	-40 °C ... 105 °C

- Levels

Parameter	Symbol	Unit	Min	Typ	Max	Comment
Low voltage	U_L	V			0.4	with $I_{outL} = 4 \text{ mA}$, unloaded
High voltage	U_H	V	$U_C - 0.4$			with $I_{outH} = -4 \text{ mA}$, unloaded

Mode 3: 2 Wires LVDS Manchester (ANSI/TIA/EIA-644-A and IEEE 802.3)

For all allowed capacitive range, recommended load resistor $R_L = 100 \text{ Ohm}$.

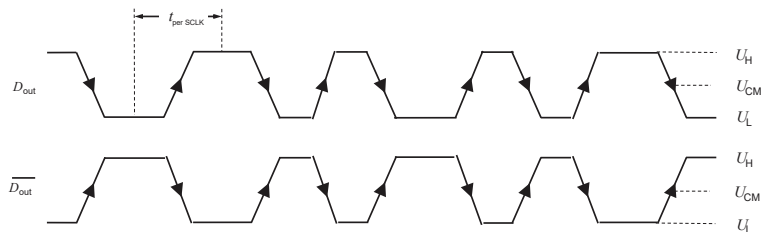

Logical 1 is coding on a rising edge on D_{out} .

- Timing for Mode 3

Parameter	Symbol	Unit	Min	Typ	Max	Comment
SCLK period	t_{SCLK}	ns	89	93.5	98	$f_{CLK} = 10.7 \text{ MHz} \pm 5 \%$
Temperature coefficient of clock period	TCT_{CLK}	ppm/K	-400	0	400	-40 °C ... 105 °C

- Levels

Parameter	Symbol	Unit	Min	Typ	Max	Comment
Low voltage	U_L	mV		$(-3.5 \times R_L) / 2$		Relative to $U_{CLK CM}$
High voltage	U_H	mV		$(3.5 \times R_L) / 2$		Relative to $U_{CLK CM}$
Clock common mode voltage	$U_{CLK CM}$	V		1.25		

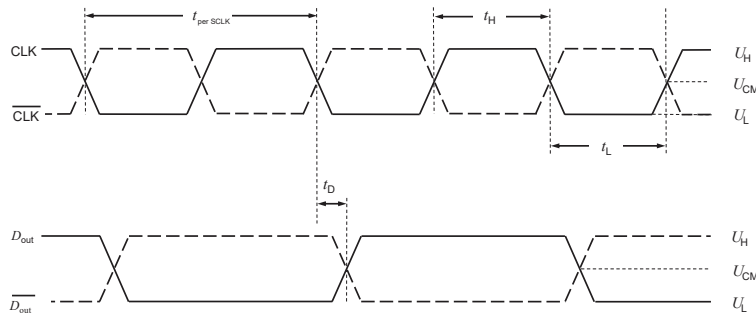
Mode 2 and A: 4 Wires LVDS (ANSI/TIA/EIA-644-A)

For all allowed capacitive range, recommended load resistor $R_L = 100 \text{ Ohm}$.

- Timing for Mode 2

Parameter	Symbol	Unit	Min	Typ	Max	Comment
SCLK period	t_{SCLK}	ns	89	93.5	98	For internal clock
Temperature coefficient of clock period	TCT_{CLK}	ppm/K	-400	0	400	-40 °C ... 105 °C
Clock high time	t_H	ns	$0.45 \times T_{\text{CLK}}$	46.75	$0.55 \times T_{\text{CLK}}$	
Clock falling edge to data delay	t_D	ns	-25	0	25	

- Timing for Mode A

Parameter	Symbol	Unit	Min	Typ	Max	Comment
Clock high time	t_H	ns	$0.45 \times T_{\text{CLK}}$	$0.5 \times T_{\text{CLK}}$	$0.55 \times T_{\text{CLK}}$	
Clock falling edge to data delay	t_D	ns	13	0	49	

In mode A, you can use external clock from 5 to 10.1 MHz or from 11.4 to 12.5 MHz.

- Levels

Parameter	Symbol	Unit	Min	Typ	Max	Comment
Low voltage	U_L	mV		$(-3.5 \times R_L) / 2$		Relative to $U_{\text{clk CM}}$
High voltage	U_H	mV		$(3.5 \times R_L) / 2$		Relative to $U_{\text{clk CM}}$
Clock common mode voltage	$U_{\text{CLK CM}}$	V		1.25		

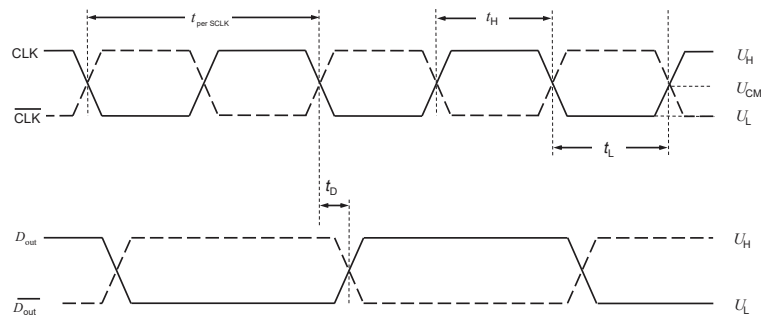
Mode 4, C and D: 4 Wires RS422 (ANSI/TIA/EIA-422-B)

For all allowed capacitive range, R_L can be 100 Ohm.

- Timing for mode 4

Parameter	Symbol	Unit	Min	Typ	Max	Comment
SCLK period	t_{SCLK}	ns	89	93.5	98	For internal clock
Temperature coefficient of clock period	TCT_{CLK}	ppm/K	-400	0	400	-40 °C ... 105 °C
Clock high time	t_{H}	ns	$0.45 \times T_{\text{CLK}}$	46.75	$0.55 \times T_{\text{CLK}}$	
Clock falling edge to data delay	t_{D}	ns	-25	0	25	

- Timing for mode C and D

Parameter	Symbol	Unit	Min	Typ	Max	Comment
Clock high time	t_{H}	ns	$0.45 \times T_{\text{CLK}}$	$0.5 \times T_{\text{CLK}}$	$0.55 \times T_{\text{CLK}}$	
Clock falling edge to data delay	t_{D}	ns	13	0	49	

In mode C and D, you can use external clock from 5 to 10.1 MHz or from 11.4 to 12.5 MHz.

- Levels

Parameter	Symbol	Unit	Min	Typ	Max	Comment
Low voltage	U_L	V			0.4	with $I_{\text{out L}} = 4 \text{ mA}$, unloaded
High voltage	U_H	V	$U_C - 0.4$			with $I_{\text{out H}} = -4 \text{ mA}$, unloaded
Clock common mode voltage in mode C	$U_{\text{CLK CM}}$	V	$0.35 \times U_C$		$0.75 \times U_C$	
Clock common mode voltage in mode D	$U_{\text{CLK CM}}$	V		0		

Mode D fully compatible with RS422 standard (ANSI/TIA/EIA-422-B).
Capacitors on CLK and \overline{CLK} signals needed to avoid common mode voltage.

Overcurrent detection OCD

Overcurrent detection is a feature included on HMSR DA product in order to detect high peaks of currents happening during operation.

Parameter	Symbol	Unit	Min	Typ	Max	Comment
Internal OCD detection threshold	$I_{I\text{OCDTh}}$	A		$3 \times I_{PN}$		
Internal OCD threshold error	$\varepsilon_{I\text{OCDTh}}$	%		± 8		Referred to I_{PN}
Internal OCD output on resistance	$R_{on\text{I}\text{OCD}}$	Ω		10	50	Open drain output, active low
Internal OCD output hold time	$t_{\text{hold}\text{I}\text{OCD}}$	μs	8	10	12	
Internal OCD delay time	$t_{D\text{I}\text{OCD}}$	μs	0.7		1.5	

Internal OCD behavior

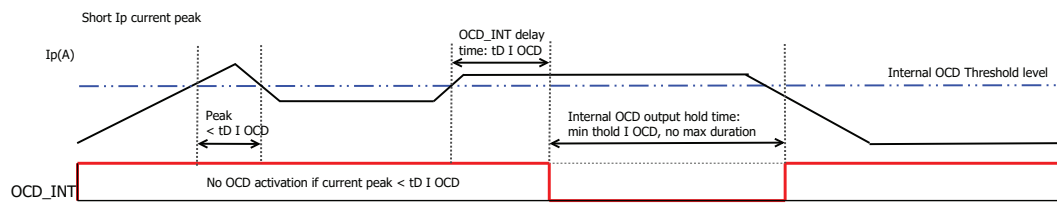
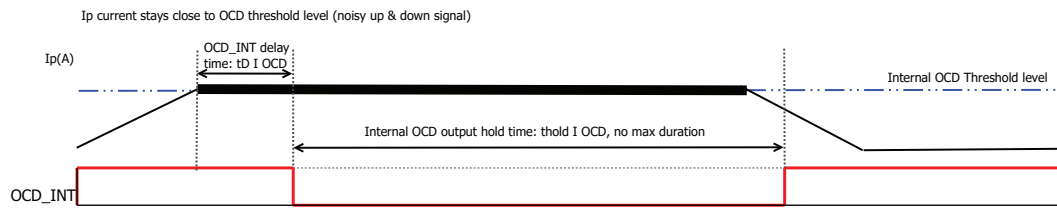
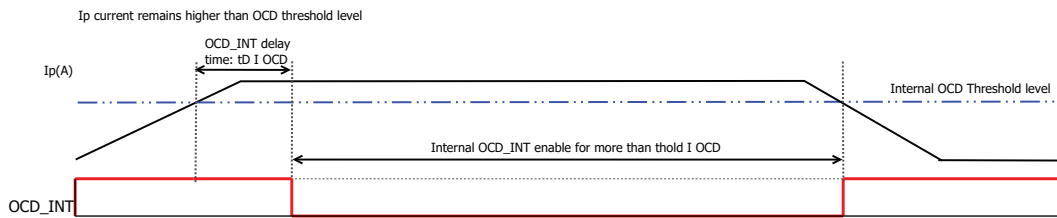

Thermal characteristics

When designing a system containing a current sensor, self-heating due to the flow of the current should be considered. When a current pass through, the sensor's temperature will increase, and this may affect its performances. This change on temperature will depend on the current profile, PCB layout, cooling techniques and copper thickness. The following plots show an example of different thermal responses of the HMSR DA sensor when used on an evaluation LEM board.

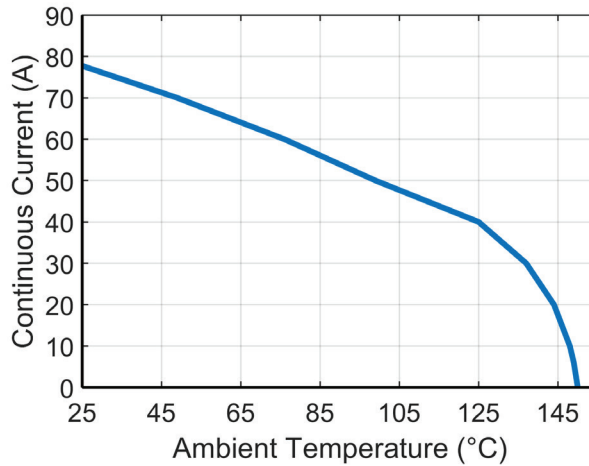

Figure 5: Continuous current vs temperature

Figure 5 shows the current derating of the sensor to avoid exceeding the T_{Jmax} on the LEM evaluation board. This highlight the thermal performance of the device, not the ability to measure.

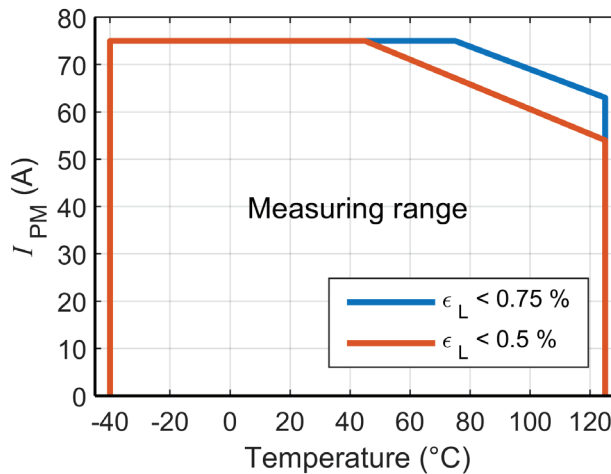
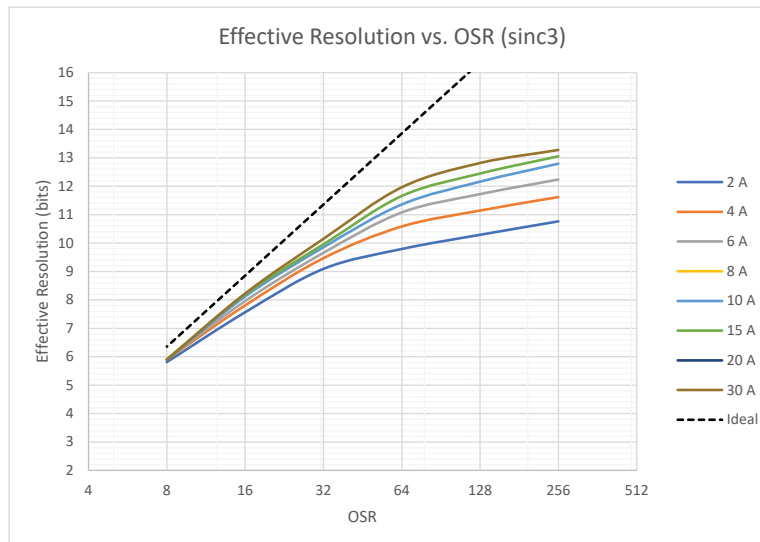
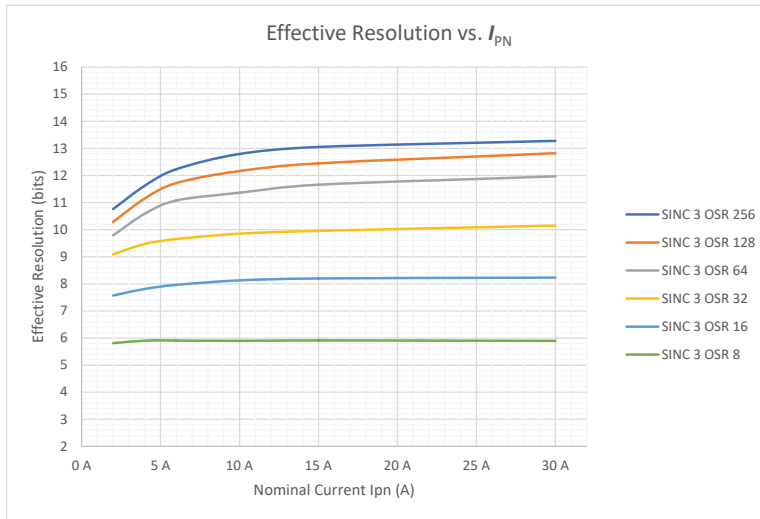

Figure 6: Measuring range vs temperature

Finally, Figure 6 represents the maximum measurement range (peak current) versus the temperature. The maximum temperature should be evaluated on the final system where the current sensor is integrated on the real application. This temperature should never exceed the maximum junction temperature as shown on the previous paragraphs.

Effective resolution versus Decimation Ratio (DR)



Delay time versus OSR

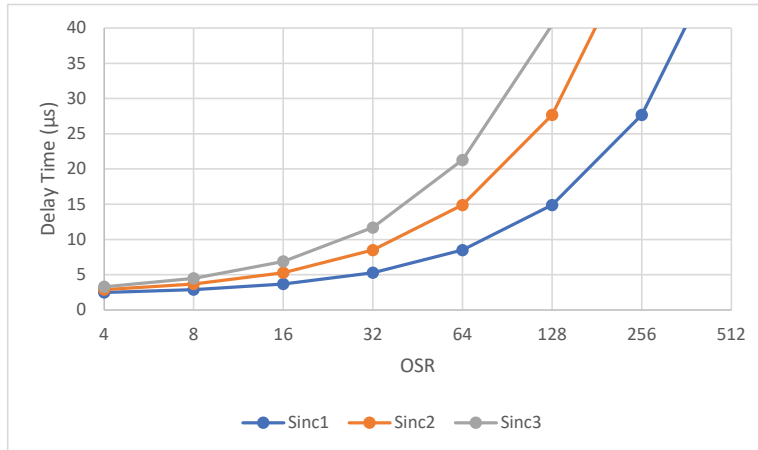

Bandwidth (-3 dB) versus OSR

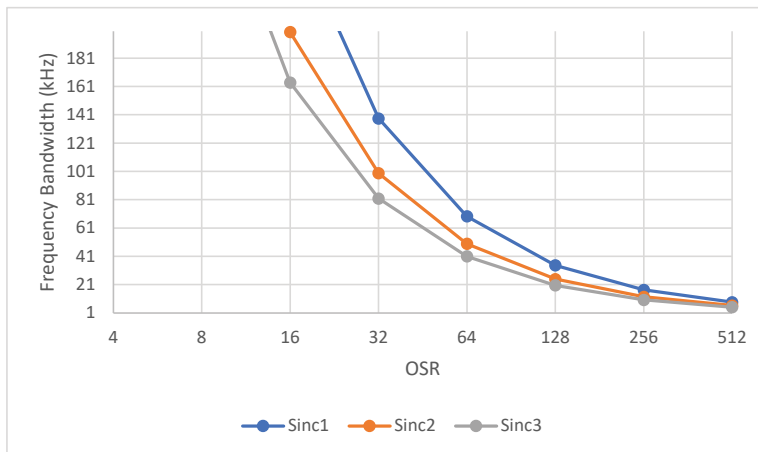

Evaluation board PCB 2702

All the above results are based on a LEM evaluation board.

This evaluation board HMSR-DA Demokit is available at our distributors or direct sales (please contact us).

Description

Evaluation board PCB is based on 6 x 105 μm (3oz) copper layers.

6 x 500 sq.mm copper stitched on primary side.

This layout improves thermal performances of the sensor.

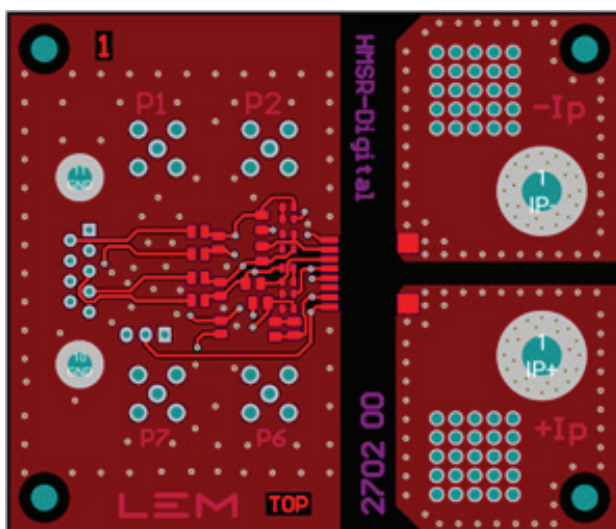
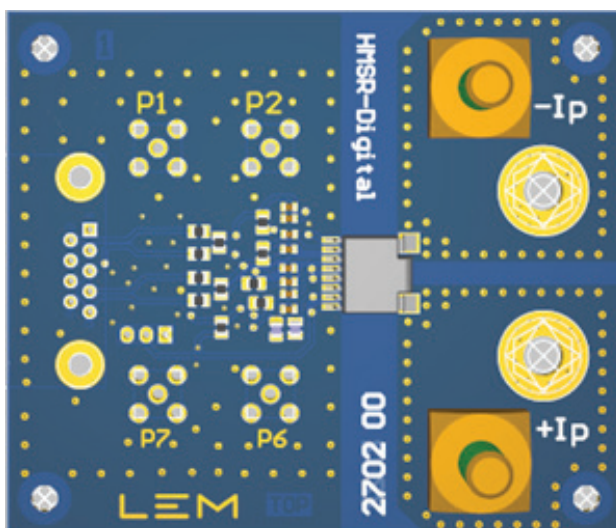

Contact LEM for more information about the evaluation board.

Terms and definitions

Total error referred to primary

The total error ϵ_{tot} is the error at $\pm I_{PN}$, relative to the rated value I_{PN} .

It includes all errors mentioned above

- the electrical offset I_{OE}
- the magnetic offset I_{OM}
- the sensitivity error ϵ_s
- the linearity error ϵ_L (to I_{PN}).

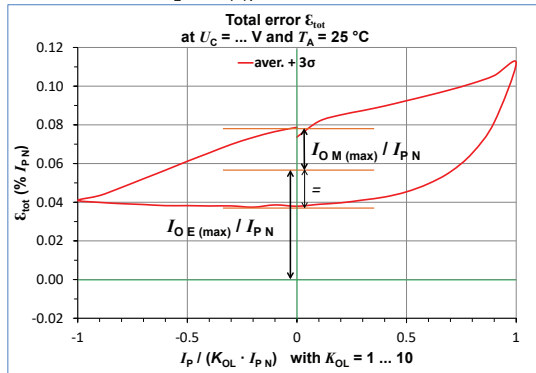

Figure 7: Total error ϵ_{tot}

Electrical offset referred to primary

Using the current cycle shown in figure 7, the electrical offset current I_{OE} is the residual output referred to primary when the input current is zero.

$$I_{OE} = \frac{I_{P(3)} + I_{P(5)}}{2}$$

$$I_{OM} = \frac{I_{P(3)} - I_{P(5)}}{2}$$

Magnetic offset referred to primary

The magnetic offset current I_{OM} is the consequence of a current on the primary side ("memory effect" of the transducer's ferromagnetic core). It is measured using the following primary current cycle. I_{OM} depends on the current value $I_P \geq I_{PN}$.

K_{OL} : Overload factor

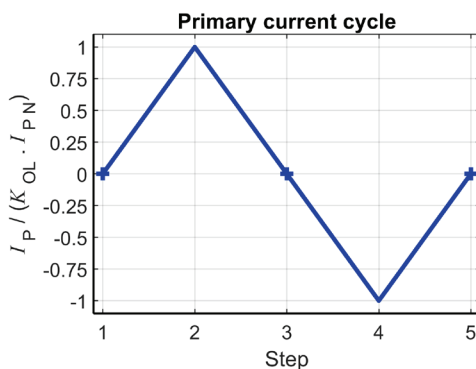

Figure 8: Current cycle used to measure magnetic and electrical offset (transducer supplied)

Sensitivity and linearity

To measure sensitivity and linearity, the primary current (DC) is cycled from 0 to I_P , then to $-I_P$ and back to 0 (equally spaced $I_{PN}/10$ steps). The sensitivity S is defined as the slope of the linear regression line for a cycle between $\pm I_{PN}$.

The linearity error ϵ_L is the maximum positive or negative difference between the measured points and the linear regression line, expressed in % of I_{PN} .

Delay times

The delay time $t_{D,10}$ @ 10 % and the delay time $t_{D,90}$ @ 90 % with respect to the primary are shown in the next figure.

Both slightly depend on the primary current di/dt . They are measured at nominal current.

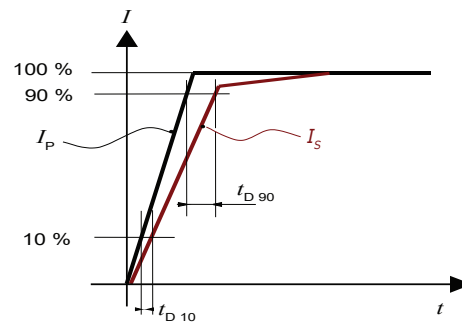

Figure 9: $t_{D,10}$ (delay time @ 10 %) and $t_{D,90}$ (delay time @ 90 %).

PCB footprint (in mm)

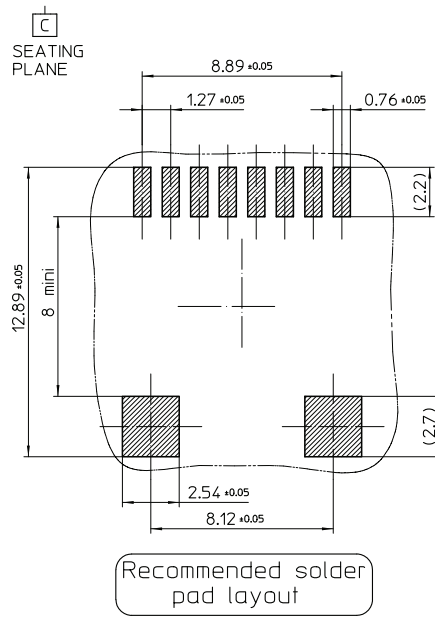

Figure 10

Soldering on PCB

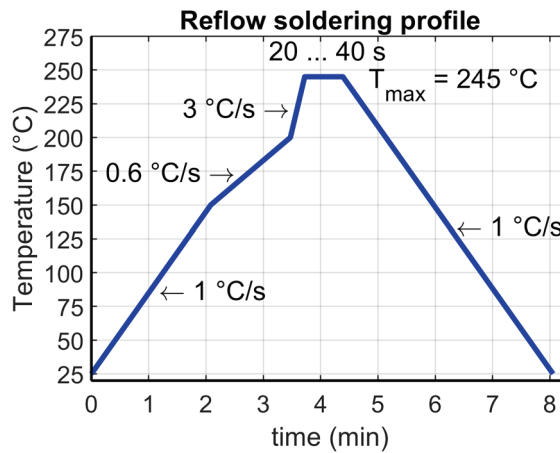
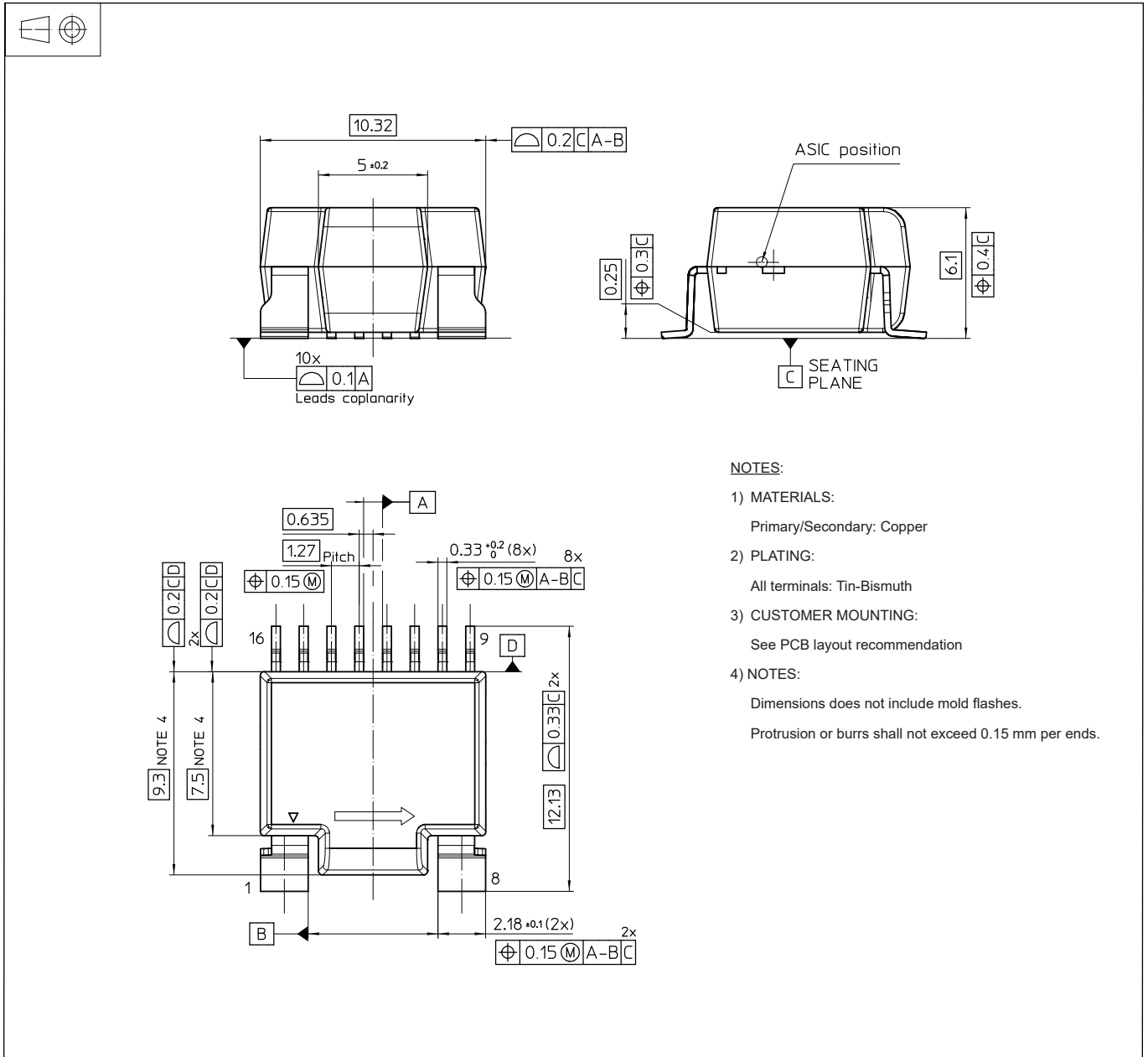

Figure 11

Soldering remarks:

- HMSR is qualified MSL1 for storage and mounting purposes.
- Per JEDEC J-STD-020E for packages more than 2.5 mm thick per table 4.2 (Pb-Free Process) of the specification.
- Best practice is to use 7 zones or greater conventional reflow system, limiting the time at reflow temperature as indicated in profile above.
- Rework not recommended.

Dimensions (in mm)



- NOTES:**
- MATERIALS:**
Primary/Secondary: Copper
 - PLATING:**
All terminals: Tin-Bismuth
 - CUSTOMER MOUNTING:**
See PCB layout recommendation
 - NOTES:**
Dimensions does not include mold flashes.
Protrusion or burrs shall not exceed 0.15 mm per ends.

Mechanical characteristic

- General tolerance ±0.15 mm

Tape & Reel (in mm)

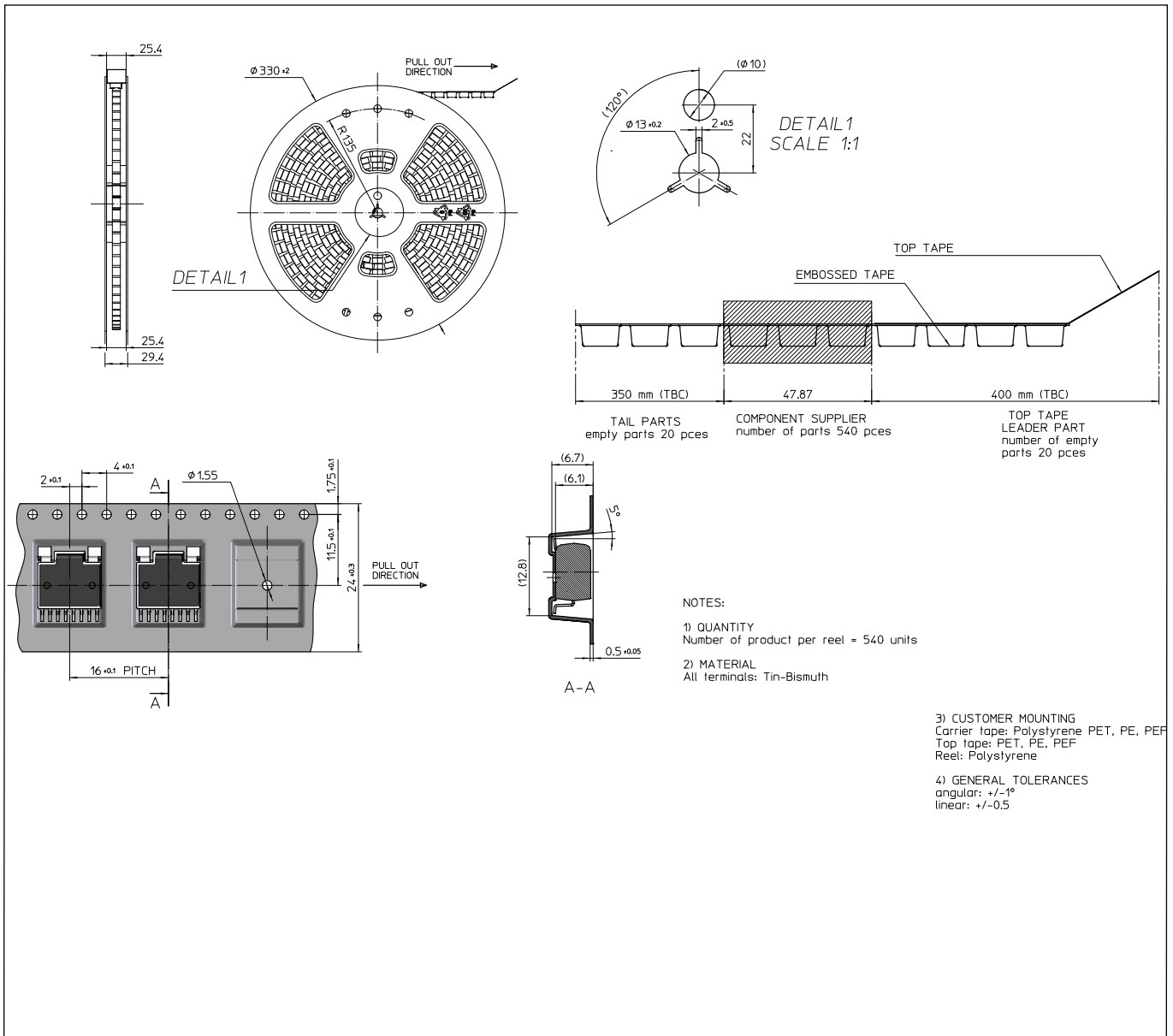



Caution

If the device is used in a way that is not specified by the manufacturer, the protection provided by the device may be compromised. Always inspect the electronics unit and connecting cable before using this product and do not use it if damaged. Mounting assembly shall guarantee the maximum primary conductor temperature, fulfill clearance and creepage distance, minimize electric and magnetic coupling, and unless otherwise specified can be mounted in any orientation.



Caution, risk of electrical shock

This transducer must be used in limited-energy secondary circuits SELV according to IEC 61010-1, in electric/electronic equipment with respect to applicable standards and safety requirements in accordance with the manufacturer's operating specifications. Use caution during installation and use of this product; certain parts of the module can carry hazardous voltages and high currents (e.g., power supply, primary conductor).

Ignoring this warning can lead to injury and or/cause serious damage.

De-energize all circuits and hazardous live parts before installing the product.

All installations, maintenance, servicing operations and use must be carried out by trained and qualified personnel practicing applicable safety precautions.

This transducer is a build-in device, whose hazardous live parts must be inaccessible after installation.

This transducer must be mounted in a suitable end-enclosure.

Besides make sure to have minimum 30 mm between the primary terminals of the transducer and other neighboring components.

Main supply must be able to be disconnected.

Always inspect the flexible probe for damage before using this product.

Never connect or disconnect the external power supply while the primary circuit is connected to live parts.

Never connect the output to any equipment with a common mode voltage to earth greater than 30 V.

Always wear protective clothing and gloves if hazardous live parts are present in the installation where the measurement is carried out.

This transducer is a built-in device, not intended to be cleaned with any product. Nevertheless, if the user must implement cleaning or washing process, validation of the cleaning program has to be done by himself.

When defining soldering process, please use no cleaning process only.



ESD susceptibility

The product is susceptible to be damaged from an ESD event and the personnel should be grounded when handling it.

Do not dispose of this product as unsorted municipal waste. Contact a qualified recycler for disposal.

Although LEM applies utmost care to facilitate compliance of end products with applicable regulations during LEM product design, use of this part may need additional measures on the application side for compliance with regulations regarding EMC and protection against electric shock.

Therefore, LEM cannot be held liable for any potential hazards, damages, injuries or loss of life resulting from the use of this product.

Version history

Date	Version	Comments
12 July 2023	0	New datasheet
4 October 2023	1	Removal of clem from datasheets and added UL 1577: 2014 (page 1); Replaced marking time by masking time; Merged "Notes* paragraphs (page 3); Deleted the line C_L (table page 4); Changed the temperature at 25 °C by 35° C in first sentence; Modified mode 4 and 8 in second table (page 7); Replaced internal OCD behavior graph (page 16); Modified figures 5, 6 and the sentence below and the title of figure 6 (page 17); Deleted connection graph (page 23); Sensitivity and offset drift presented in envelope.